

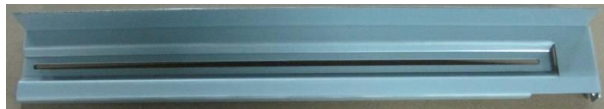

Right slider x 1

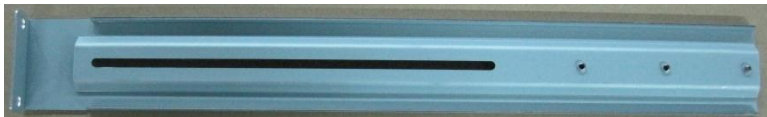

Left slider x 1



Middle support slider x 2

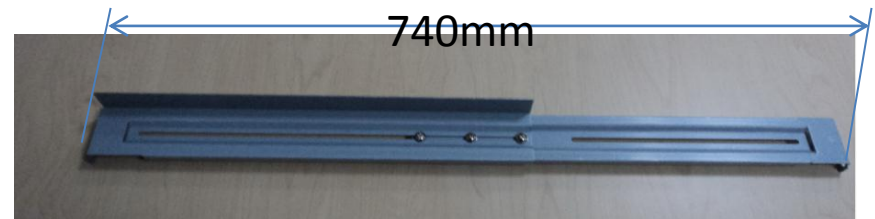
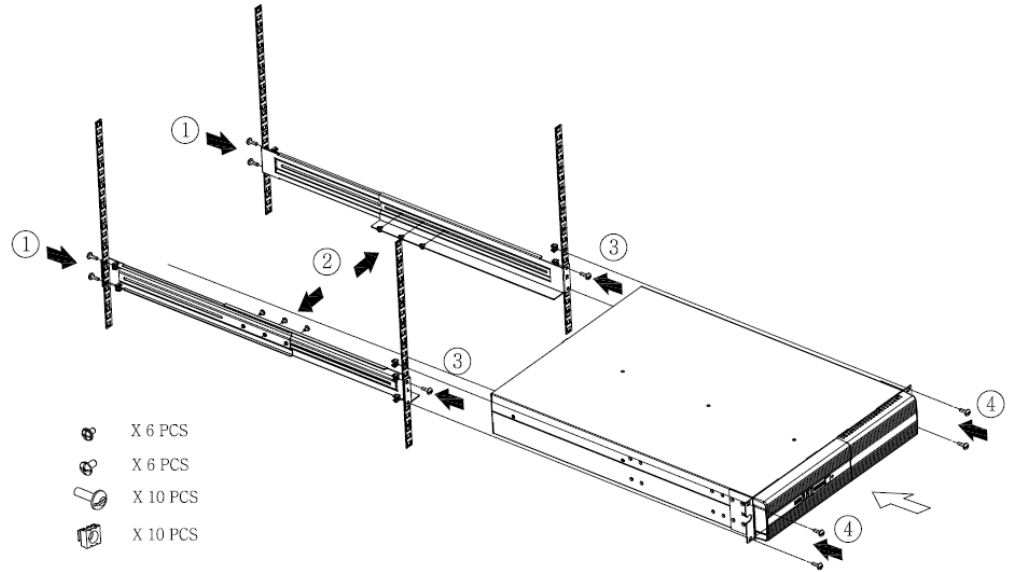

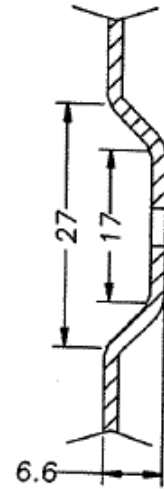
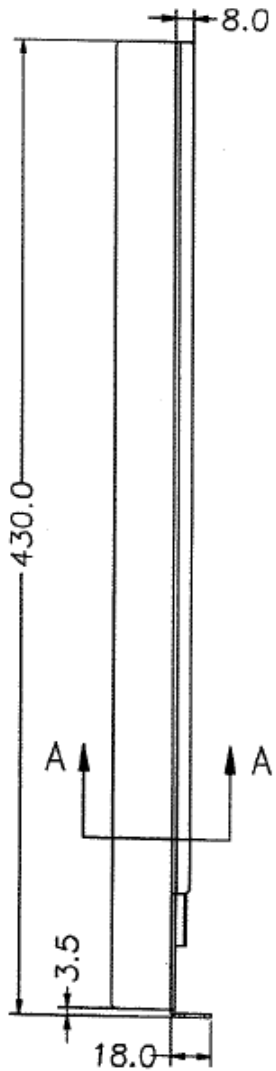

SECTION A-A
SCALE: 4:1

Right slider x 1

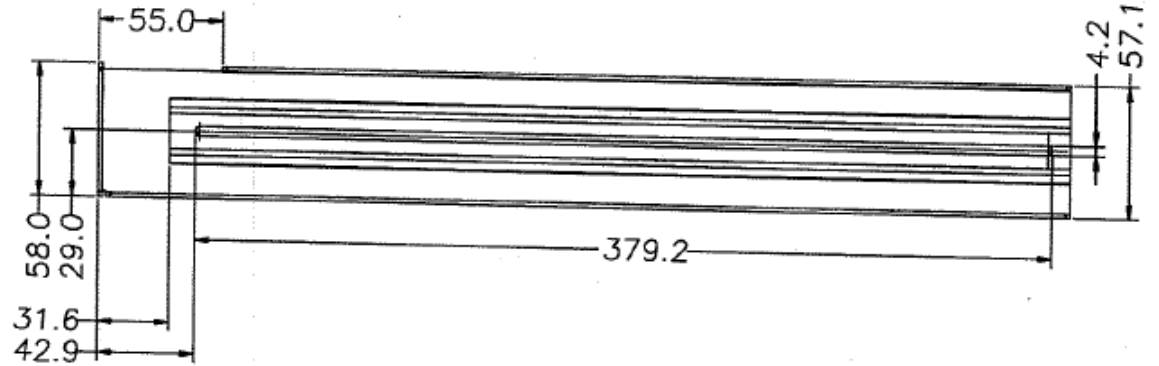
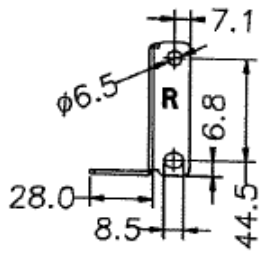

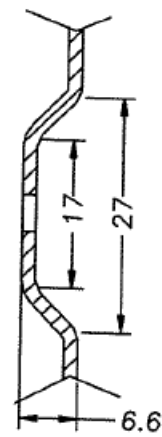
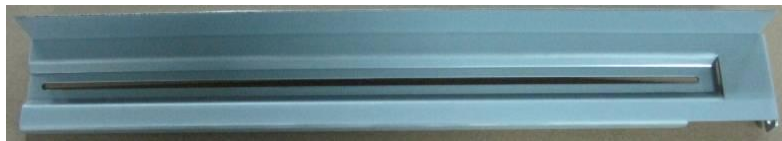
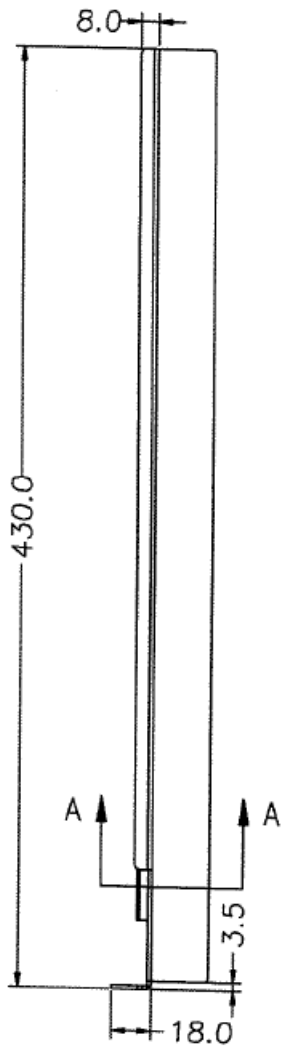

SECTION A-A
SCALE: 4:1

Left slider x 1

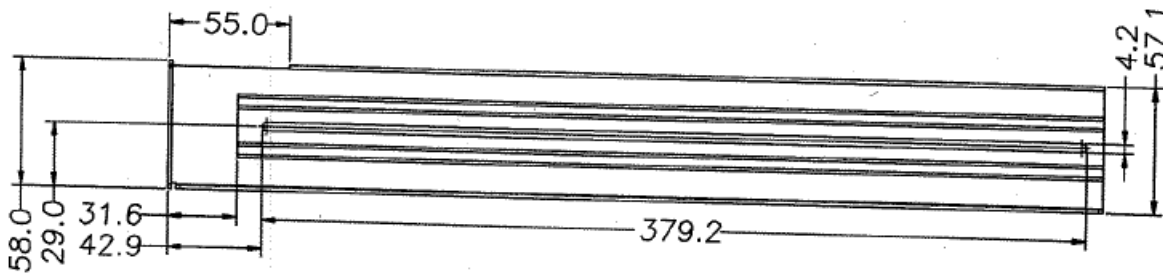
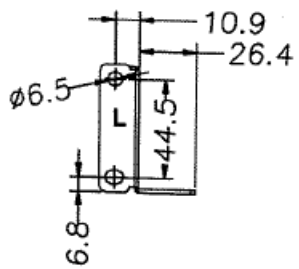

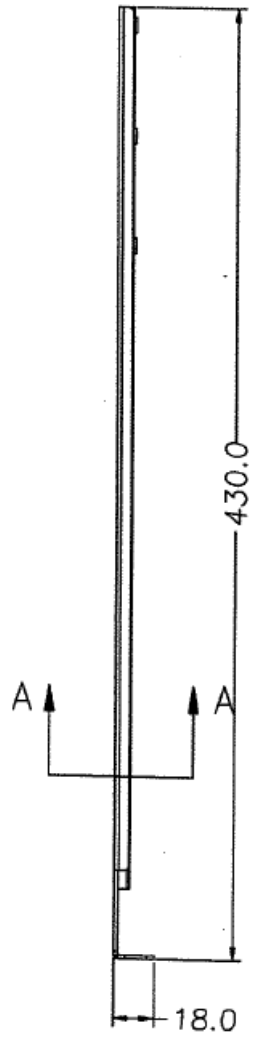

Middle support slider x 2

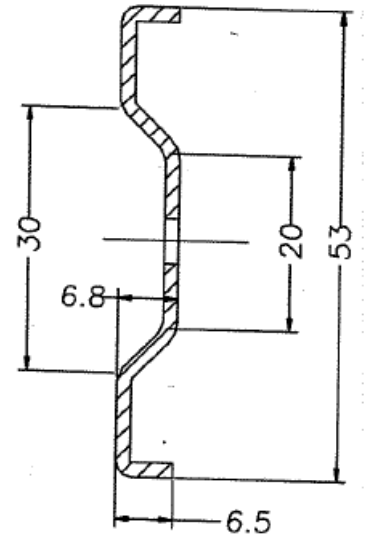

SECTION A-A
SCALE: 4:1

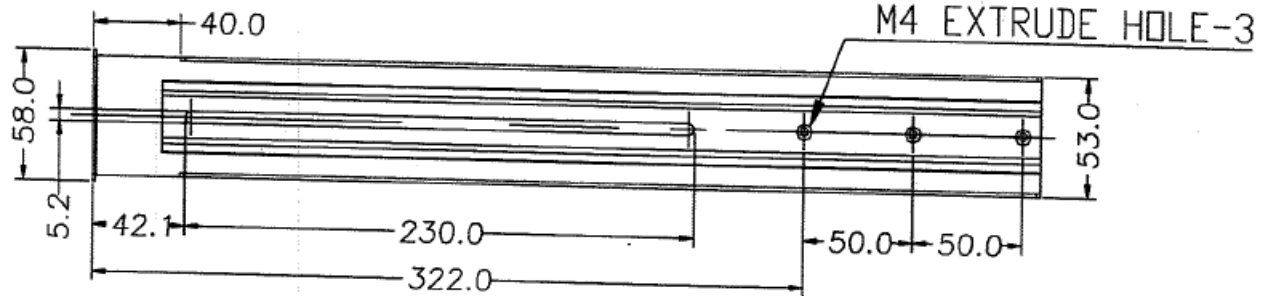
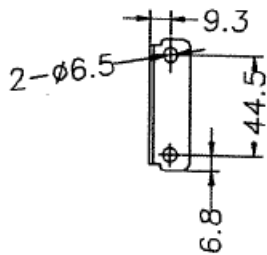

Gross Weight for Master carton (20 set of rail kit): 37.78kg



Gross Weight for Individual carton (1 set of rail kit): 1.8kg .

